

EBOX-3300A / 3310A series

User's Guide



Copyright

The information in this manual is subject to change without notice for continuous improvement in the product. All rights are reserved. The manufacturer assumes no responsibility for any inaccuracies that may contain in this document, and makes no commitment to update or to keep current information contain in this manual.

No part of this manual may be reproduced, copied, translated or transmitted, in whole or in part, in any form or by any means without the prior written permission of the DMP Electronics Inc.

©Copyright 2011 DMP Electronics Inc.

Special Notice to Users

DMP Electronics Inc. provides no warranty with regard to this manual, the software, or other information contained herein and hereby expressly disclaims any implied warranties of merchantability or fitness for any particular purpose with regard to this manual, the software, or such other information. In no event shall DMP Electronics be liable for any incidental, consequential, or special damages, whether based on tort, contract, or otherwise, arising out of or in connection with this manual, the software, or other information contained herein or the use thereof.

DMP Electronics reserves the right to make any modification to this manual or the information contained herein at any time without notice. The software described herein is governed by the terms of a separated user license agreement or label sticker.

This product contains software owned by DM&P and licensed by third parties. Use of such software is subject to the terms and conditions of license agreements enclosed with this product. Software specifications are subject to change without notice and may not necessarily be identical to current retail versions.

Updates and additions to software may require an additional charge. Subscription to online service providers may require a fee and credit card information. Financial services may require prior arrangements with participating financial institution.

Trademarks Acknowledgment

The EBOX-3300A/ 3310A series is the registered trademarks of DMP Electronics Inc. Microsoft®, Windows®, and AMI are registered trademarks of Microsoft Corporation and American Megatrends Inc. in the United States and/or other countries respectively.

Other brand names, product names or trade names appearing in this document are the properties and registered trademarks of their respective owners. All names mentioned herewith are served for identification purpose only.

Safety Information

WARNING

- Do not expose EBOX-3300A/ 3310A series to rain or moisture, in order to prevent shock and fire hazard.
- Never install EBOX-3300A/ 3310A series in wet locations.
- Do not open the cabinet to avoid electrical shock. Refer to your nearest dealer for qualified personnel servicing.
- Never touch un-insulated terminals or wire unless your power adaptor and display monitor are disconnected.
- Locate EBOX-3300A/ 3310A series as close as possible to the socket outline for easy access and to avoid force caused by entangling of your arms with surrounding cables from the EBOX-3300A/ 3310A series.
- When using EBOX-3300A/ 3310A series, avoid using or installing the modem to the serial port during a storm or a lightning.
- Do not use the modem or a telephone to report a gas leak in the vicinity of the leak.
- USB connectors are supplied with Limited Power Sources.

DO NOT ATTEMPT TO OPEN OR TO DISASSEMBLE THE CHASSIS (ENCASING) OF THIS PRODUCT. PLEASE CONTACT YOUR NEAREST DEALER FOR SERVICING FROM QUALIFIED TECHNICIAN.

Regulatory

FCC Class A Note

This equipment has been tested and found to comply with the limits for a Class A digital device, pursuant to Part 15 of the FCC Rules. These limits are designed to provide reasonable protection against harmful interference when the equipment is operated in a commercial environment. This equipment generates, uses and can radiate radio frequency energy and, if not installed and used in accordance with the instruction manual, may cause harmful interference in which case the user will be required to correct the interference at his own expense. Testing was done with shielded cables. Therefore, in order to comply with the FCC regulations, you must use shielded cables with your installation.

WARNING

This product complies with EN55022 class A. In a domestic environment this product may cause radio interference in which case the user may be required to take adequate measures.

Changes or modifications to this unit not expressly approved by the party responsible for compliance could void the user's authority to operate the equipment.

This device complies with Part 15 of the FCC rules. Operation is subject to the following two conditions: (1) this device may not cause harmful interference, and (2) this device must accept any interference received, including interference that may cause undesired operation.

This digital apparatus does not exceed the Class A limits for radio noise emissions from digital apparatus as set out in the interference - causing equipment standard entitled "Digital Apparatus", ICES-003 of the Department of Communications.

Manufacturer's Declaration of Conformity

This equipment has been tested and found to comply with the requirements of European Community Council Directives 89/336/EEC and 73/23/EEC relating to electromagnetic compatibility and product safety respectively.

Attention

This product has been designed and certified to comply with certain regulatory requirements pertaining to Information Technology Equipment. This product has not been designed for use as a medical device. Without limitation of the foregoing, this product is not intended and has not been certified for use in a hospital or clinical environment to diagnose, treat, or monitor patients under medical supervision, and is not intended and has not been certified to make physical or electrical contact with patients, nor to transfer energy to or from patients and/or to detect such energy transfer to or from patients.

Purchase Agreement

Purpose:

In accordance to the general commercial conduct of Trust and Fair Trade, herewith below is the agreement for the protection for both parties, DMP and Users in pursuant of trading.

Product Description:

With this product, herewith also known as EBOX-3300A/ 3310A series which is a simplified & an economical design of an embedded device for Special Purpose Personal Computing. The basic specification of this product comprises of the x86 technology designs, and with onboard 256MB/ 512MB DDR2 System memory, VGA display, USB, PS/2 Keyboard/ Mouse, LAN and Audio Interfaces.

Distribution Convention:

1. This Product includes a gift box, an inner case, a PC, a Power adaptor, (and IDE cable will be included only for EBOX-3300A/ 3310A-H package). Upon receiving this product, please refer to the User' Manual to check for the contents and appearance of this product; contact immediately your nearest dealer or DMP office for any defective or missing parts. The supplier will not be responsible for any reported discrepancy thereafter the expiration period of 3-days from the date of purchase.
2. In consideration of transportation and the cost of storage, the supplier provides to the distributors a warranty of 12-months. This warranty covers the failure caused by hardware breakdown (excluding hard drives), but does not cover the act of misuse and mishandling.
3. The supplier will not accept unknown post, therefore if you wish to repair or to return your goods – kindly please contact your nearest dealer to make your declaration, and at the same time, apply for a RMA number (RMA stands for Return Merchandise Authorization – please ask for RMA form and fill-up for authorization).
4. The freight for return goods for repair will follow the International customary practice and convention: Both parties is to pay for freight of one shipment each. The shipper is required to prepay the freight from the place of origin (This means that the returnee (user) covers the freight for return goods, while the Supplier covers the freight for goods after the repair).
5. Obsolete warranty is referred to as: (1) Expiration of warranty or (2) Damage due to misuse within warranty. The Supplier will be taken into consideration of the circumstances, to provide repair service with charges expense for obsolete warranty. This expense includes the cost of material and the cost of labor.

Note: If there is other particular issue not listed in the above conditions, both parties agreed to follow the General Law of Commerce with fair and reasonable discussion in handling and resolving the argument.

Contents

Chapter 1

02 Unpacking your EBOX Mini PC

Chapter 2

05 EBOX-3300A/ 3310A series Overview

06 System Specifications

07 Peripherals Connecting

Chapter 3

11 BIOS Reconfiguring

11 Path to the Watchdog configuration

12 Debian / Ubuntu Linux Installation Guide

Chapter 4

16 Technical Specifications

Chapter 5

18 Onboard Connectors Summary

20 Pin Assignments

Chapter 6

23 Taking Care Your EBOX VESA PC

24 Cleaning Your EBOX VESA PC

25 Troubleshooting

Chapter 7

28 Terms and Condition

28 Warranty

28 Service and Support

28 Return Merchandise Authorization (RMA) Policy

28 Shipping Policy

Chapter 1

Unpacking Your EBOX Mini PC

Congratulation! You have just acquired EBOX-3300A/ 3310A series, please check the following items.

Packing List:

Item No.	Description	Q'ty
1	EBOX-3300A/ 3310A series VESA PC	x1
2	Max. 10 - watts External Power Adaptor, Vin: 100~240VAC 50/ 60Hz, 0.45A / Volt: +5.0 VDC @ 2.0A Max.	x1

Note: The accessories are subject to change without immediate notice.

Check before Use



Preface

EBOX-3300A/ 3310A series: VESA PC

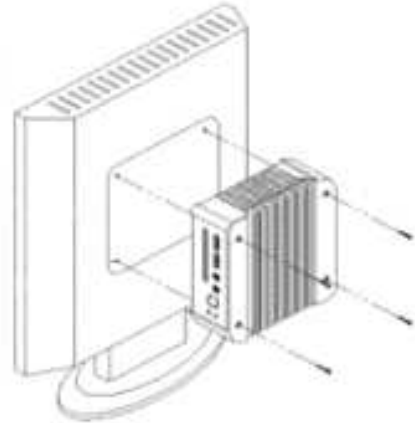

The EBOX-3300A/ 3310A series is a revolutionary device which is especially designed for limited physical space and temperature concerns. No matter you are in a jammed office, a crowded place, or public transportation, it can be easily integrated with a VESA LCD to bring you EBOX-3300A/ 3310A series access at any time.

It can attach to any VESA mounting fixture; allowing it to be securely mounted onto desks, walls, or buildings, and thereby optimizes your work area. It can also attach directly to any size LCD for a mobile system for the use at trade shows, presentations, promotions, etc. Unlike traditional portable laptop design, the EBOX-3300A/ 3310A series can be used with a large size LCD. Furthermore, with FANLESS design, EBOX-3300A/ 3310A series is ideal to be used in the environment where temperature demand is critical.

So, if you are looking for a device that is able to provide you with more mobility & space but at the same time uses less power consumption, then EBOX-3300A/ 3310A series will be surely meet your need.

The VESA® FDMI™ Standard defines mounting interfaces, hole patterns and associated cable/ power supply locations for LCD monitors, plasma displays and other flat panel devices. EBOX-3300A/ 3310A series is designed to fit this standard to make monitor attachment quickly and easy.

Chapter 2

EBOX-3300A/ 3310A series Overview

Front Panel

Power LED

The power LED lights up when system is turn on.

HDD LED

LED flashes when the system is accessing Hard Drive.

Audio Line Out

Audio output to speaker

Audio Mic In

For Microphone Input

CF & Micro SD Slot

The system is bootable from Compact Flash Card and Micro SD (T-flash).

USB ports

For connection to devices with USB interface (HDD, CD/DVD-ROM, Memory Stick, etc.)



Back Panel

DC Power Jack

PS/2 Keyboard or Mouse (6-pin)

VGA

USB Port

RJ-45 LAN Jack

Wireless Antenna connector (optional)

RS-232

Power switch

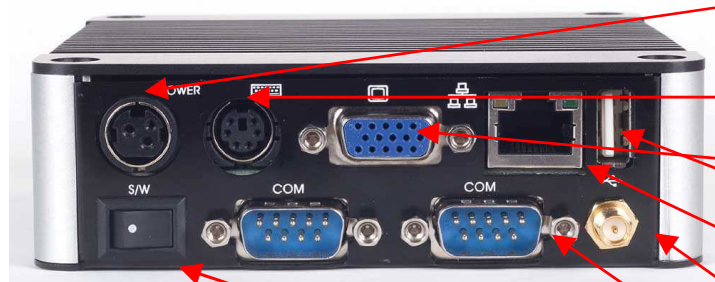

System Specification

CPU

MSTI-PDX-600 (System on Chip)

Main Memory

256 MB DDR2

512 MB DDR2

(512MB DDR2 version called 3310A series)

BIOS

AMI BIOS

VGA

XGI Z9S with 32 MB DDR2

Resolution up to 1,280 x 1,024 High Colors

Keyboard and Mouse

PS/2 Keyboard and Mouse

On-Board IDE

Enhanced IDE interface, 44 – pin box header x 1

Peripheral

1. USB V2.0 (host) x 3
2. Type I / II CF Slot and Micro-SD
3. Serial ports x 2 (available for EBOX-3300A/ 3310A-JSK)
4. Audio (Mic In, Line Out)
5. Mini PCI socket x 1 (available for EBOX-3300A/ 3310A-M and 3300A/ 3310A-JSK)
6. 2nd RJ-45 LAN (only available for EBOX-3300A/ 3310A-L2)

Dimension & Weight

115 x 115 x 35 mm / 505g

Operating System

Windows XP Home/ Pro

Windows XP Embedded

Windows Embedded CE

Supported Linux Distribution list:

1. Debian 4.0
2. Debian 5.0
3. Ubuntu 8.04
4. Ubuntu 8.10
5. **Ubuntu 9.04**
6. Ubuntu 10.04
7. **Edubuntu 9.04 (Ubuntu 8.10 base)**
8. **Easy Peasy 8.10**
9. Puppy 4.2.1
10. Puppy 4.1.2
11. WattsOS2 Warp30 (Ubuntu 8.10 base)

※ Red letters: Standard IDE compatible option enable could help for install directly

※ Ubuntu 8.10 / WattOS, Remember to enable the Media Port Instruction option for VGA compatible

Peripherals

Connecting the Power Adaptor



DC Power Jack

To use EBOX-3300A/ 3310A series immediately, please attach the supplied adapter for the power source. See the left diagram for visual connection.

Connect the DC power jack of the power adaptor to the DC Input of EBOX-3300A/ 3310A series.

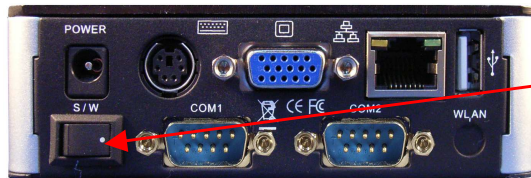

Turning ON EBOX-3300A/ 3310A series

Switch on power as indicated on your left-side figure, the system will start automatically.

Connecting the Monitor



VGA Connection

Make your LCD display connection with the VGA cable to the 15-pin D-Sub VGA port.

Peripherals

Connecting the USB

EBOX-3300A/ 3310A series provide Three external USB ports with (Two at the front, One at the rear) and one internal USB port.

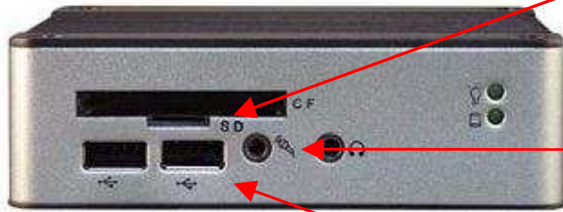

Micro-SD and CF Slot

For connecting to Device with Compact Flash Card and Micro-SD (T-flash).

Microphone/Earphone

The EBOX-3300A/ 3310A series supports Microphone Input and Speaker Output.

USB Ports

The USB ports are available for connection to USB devices such as CD-ROM / Pen Drive.

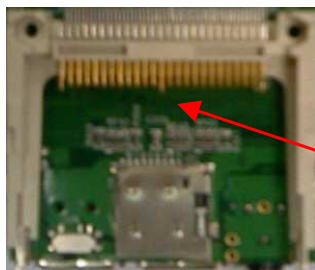

(Inside CF Slot)

Secondary IDE Master / Slave

Adjust for Compact Flash device to be Secondary IDE Master or Slave.

Connecting the LAN



RJ-45 LAN

There is an available RJ-45 LAN jack for Ethernet connection.
(See left diagram for RJ-45 Jack).

Connecting the Keyboard and Mouse

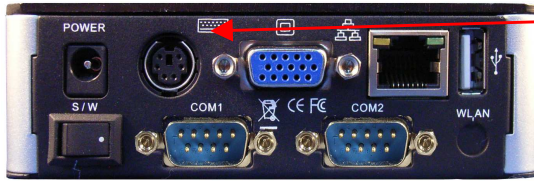

PS/2 Keyboard or Mouse (6-pin)

This PS/2 Port is shared for connecting Keyboard and/ or Mouse by using Split Y-Cable (not included).

Connecting Serial port

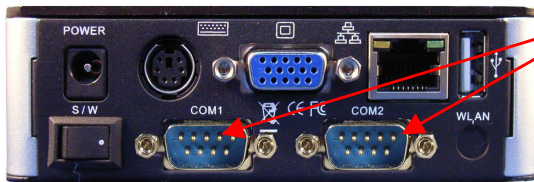

Serial Ports (Optional)

The serial port is usually connected to a serial device like modem or terminal devices. (Option for EBOX-3300A / 3310A-JSK)

Connecting 2nd LAN port



2nd LAN port

The 2 LAN ports version allows user to connect 2 LAN (Option for EBOX-3300A / 3310A-L2)

Chapter 3

BIOS Reconfiguring

1. Take note that AMI BIOS is used in the EBOX-3300A/ 3310A series. To reconfigure the EBOX-3300A/ 3310A series, press or hit the key to enter your BIOS setup main menu.
2. Select from the menu, the desired setup for change.
3. Press <Esc> to go back to main menu.
4. Press <F9> to load factory default setting.
5. Move to "Exit" TAB and select "Save Settings and Exit", press "Y" to save the changes that you just made. EBOX-3300A/ 3310A series will restart accordingly to your new setup.

```

Main  Advanced  PCIPnP  Boot  Security  Chipset  Exit
*****
* System Overview *
* ***** *
* Processor *
* Vortex86DX A9121 *
* Speed :1000MHz *
* | *
* System Memory *
* Size :256MB *
* Speed :333MHz *
* *
* System Time [14:27:44] *
* System Date [Fri 07/03/2009] *
* *
* ** Select Screen *
* ** Select Item *
* +- Change Field *
* Tab Select Field *
* F1 General Help *
* F10 Save and Exit *
* ESC Exit *
* *
*****
v02.58 (C)Copyright 1985-2009, American Megatrends, Inc.
```

(AMI BIOS Setup menu)

Path to the Watchdog Configuration

1. Press get into BIOS, then choose Chipset.
2. Select Southbridge Configuration.
3. Press " F8 " the hiding option will show, choose Watchdog Configuration.

Debian / Ubuntu Linux Installation Guide

In the DX platform, with the newer IDE and Ethernet controller, both of the two controllers just start supported from kernel 2.6.28.3. Please refer to the guide to help you complete the installation.

How to install Linux on Vortex86DX platform?

Preparation:

1. The Linux installation DISC (Ubuntu8.04, 9.04, 10.04, Debian4.0, 5.0)
2. A completely formatted storage (CF, Micro SD or 2.5" IDE HDD)
3. Intel/ AMD platform Personal Computer
4. Confirm the BIOS setting
 - A. IDE Configuration\ IDE mode >> **Native mode**
 - B. USB Configuration\ USB 2.0 Controller Mode >> **Fullspeed**
5. The 2.6.30 or higher kernel package DMP provided for Vortex86DX platform

Note: The completely formatted storage is helpful to avoid some unexpected error in the procedure. After you plug all the devices and ready to install, please follow the steps as below:

Step1:

Please follow the standard procedure to install the Linux OS base on the Intel or AMD platform first, and make sure your Linux can boot up normally, after install completed.

Step2:

A. Copy the .deb file (kernel package) that DMP provided into your USB pen driver or other removable storage.

B. Press **Ctrl** + **Alt** + **F1** keys to enter text mode.

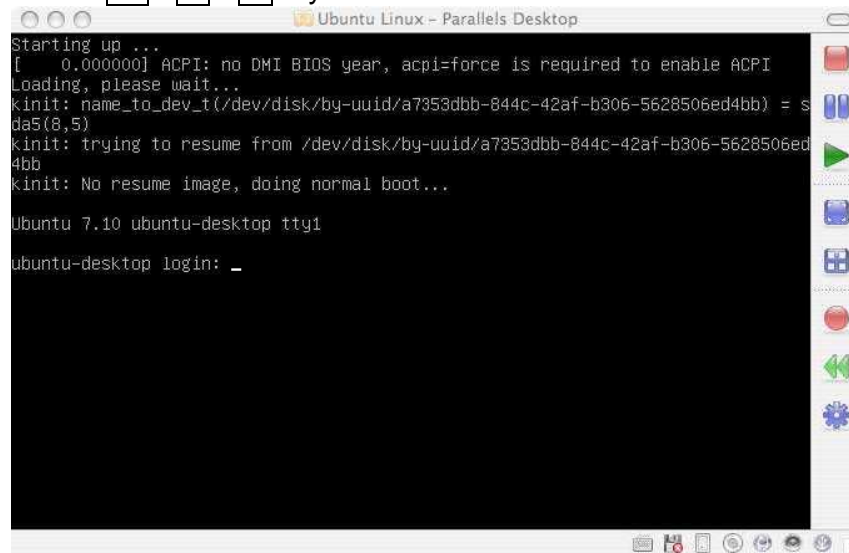

```
Starting up ...
[ 0.000000] ACPI: no DMI BIOS year, acpi=force is required to enable ACPI
Loading, please wait...
kinit: name_to_dev_t(/dev/disk/by-uuid/a7353dbb-844c-42af-b306-5628506ed4bb) = s
da5(8,5)
kinit: trying to resume from /dev/disk/by-uuid/a7353dbb-844c-42af-b306-5628506ed
4bb
kinit: No resume image, doing normal boot...

Ubuntu 7.10 ubuntu-desktop tty1

ubuntu-desktop login: _
```

The system would ask you to enter your user name and password.

C. Plug on the USB pen driver and try to mount it as mnt.

```
#sudo su
#mount /dev/sda1 /mnt
#cd /mnt
Confirm the actual codename to mount.
```

D. To unpack the kernel package and update.

```
# dpkg -i xxx.deb  
# update-initramfs -k 2.6.30-vortex86mx -c  
# update-grub
```

E. When these three procedures completed, type reboot to reboot system.

```
# reboot
```

Step3:

Moving the storage installed Linux, back to VortexDX platform.

Step4:

Turn on the power to boot.

For Ubuntu

When it start booting, press the **Esc** key when it boot. Confirm the Grub list first. There should has an option 2.6.30-vortex86mx, and then to boot.

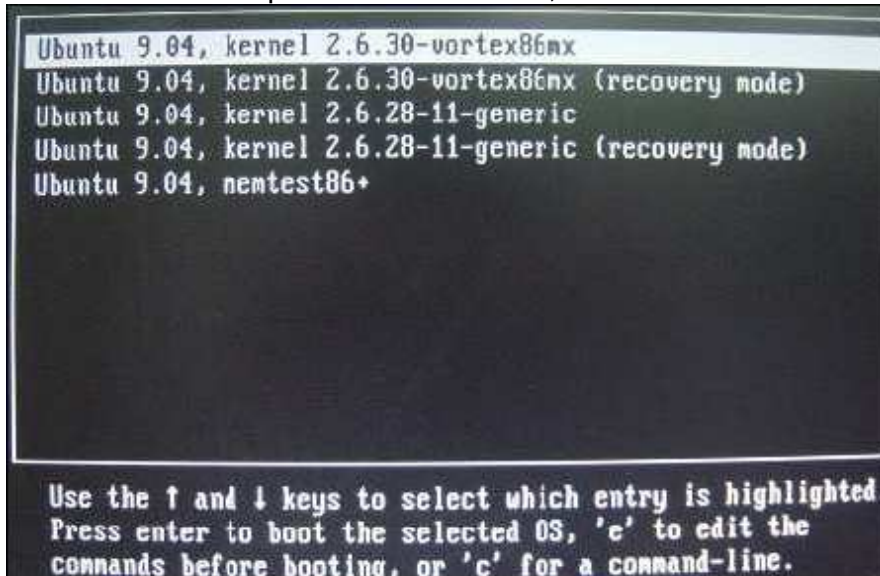

```
Ubuntu 9.04, kernel 2.6.30-vortex86mx
Ubuntu 9.04, kernel 2.6.30-vortex86mx (recovery mode)
Ubuntu 9.04, kernel 2.6.28-11-generic
Ubuntu 9.04, kernel 2.6.28-11-generic (recovery mode)
Ubuntu 9.04, nemtest86+
```

Use the ↑ and ↓ keys to select which entry is highlighted.
Press enter to boot the selected OS, 'e' to edit the
commands before booting, or 'c' for a command-line.

For Debian

Please press the **Esc** key to confirm Grub list and press **E** key to confirm and modify the storage's codename.

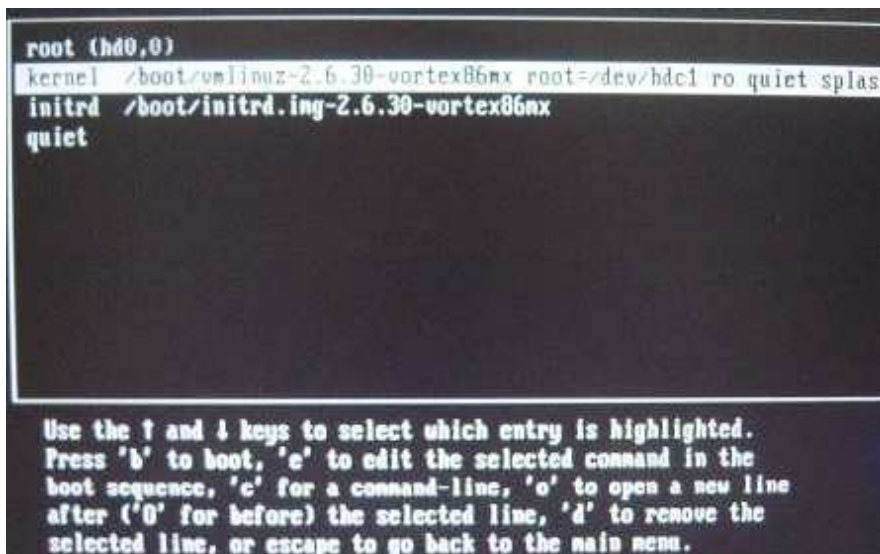

```
root (hd0,0)
kernel /boot/vmlinuz-2.6.30-vortex86mx root=/dev/hdc1 ro quiet splash
initrd /boot/initrd.img-2.6.30-vortex86mx
quiet
```

Use the ↑ and ↓ keys to select which entry is highlighted.
Press 'b' to boot, 'e' to edit the selected command in the
boot sequence, 'c' for a command-line, 'o' to open a new line
after ('O' for before) the selected line, 'd' to remove the
selected line, or escape to go back to the main menu.

Note: The Grub list parameters you can modify in the file `/boot/grub/menu.lst`.

- Primary / Master = hda1
- Primary / Slaver = hdb1
- Secondary / Master = hdc1
- Secondary / Slaver = hdd1

Chapter4

Technical Specification

Model Type	3300A	3300A-H	3300A-M	3300A-JSK	3300A-L2	
	3310A	3310A-H	3310A-M	3310A-JSK	3310A-L2	
Processor	MSTI PDX-600 (600 MHz)					
Memory	Onboard 256MB DDR2/ Onboard 512 MB DDR2					
BIOS	AMI BIOS					
VGA	XGI Z9s with 32MB DDR2/ D-Sub 15 Pin					
Ethernet	10/100 Mbps LAN Built-in PXE diskless boot function				LAN x 2	
USB	3 ports (2 at the front, 1 at the rear)					
Audio	Mic in and Line out					
MIO	Micro SD	1x				
	Type I/II CF Slot	1x				
	RS-232	N/A		2x		
	PS2	PS/2 for keyboard/ Mouse x 1			N/A	
	Mini PCI Slot	N/A		1x		N/A
	IDE	N/A	1x	N/A		
Power	+5V @ 2A (10W)					
Dimensions	115x115x35 mm					
Weight	505g					
Operation Temp.	5~50 °C					
Certification	CE, FCC, VCCI					

Note:

1. Mini-PCI Connector is available for EBOX-3300A/ 3310A-M and EBOX-3300A-JSK/ 3310A-JSK
2. 2nd RJ-45 Ethernet is only available on EBOX-3300A-L2/ 3310A-L2
3. RS-232 is available for EBOX-3300A-JSK/ 3310A-JSK and EBOX-3300A-L2/ 3310A-L2

EBOX-3300A/ 3310A series Models Listing:

EBOX-3300A/ 3310A: Standard Version

EBOX-3300A-M/3310A-M: Standard Version with Mini PCI support

EBOX-3300A-H/ 3310A-H: Standard Version with 2.5" IDE support

EBOX-3300A-JSK/ 3310A-JSK: Standard Version with Mini PCI support and 2 x RS-232 ports

EBOX-3300A-L2 / 3310A-L2: Standard Version with 2 x LAN and 2 x RS-232 ports, no PS/2

EBOX-3300A-LS / 3310A-LS: Standard Version with 128MB CF card + DMP Embedded Linux OS

Chapter 5

Onboard Connectors Summary

Summary Table for CPU Board

Nbr	Description	Type of Connections	Pin nbrs.
J1	IDE connector	Box Header 22 x 2 2.0mm	44-pin
J3	USB (Front)	USB Connector	8pin
J4	USB (Front)	USB Connector	8-pin
J5	USB (Front)	USB Connector	8-pin
J6	JTAG connector	Wafer 1.25mm	6-pin
J8	PS/2 connector	Mini Din connector	6-pin
J9	COM1 Port	Box Header 5x2 2.0mm	10-pin
J11	COM2 Port	Box Header 5x2 2.0mm	10-pin
J12	DC 15V Input	Mini DIN Connector	3-pin
J13	Power Switch	Power Switch	4-pin
J14	Mini PCI	Mini PCI socket	124-Pin
J15	VGA connector	D-Sub Connector	15-pin
J18	Secondary IDE Master	Dip Switch	2-pin
J19	Line-Out	Audio Jack	2-pin
J20	Microphone	Audio Jack	2-pin
JP1	JTAG enable	Jumper	2-pin
LAN	Ethernet LAN	RJ-45	8-pin

► Front Connectors Outline

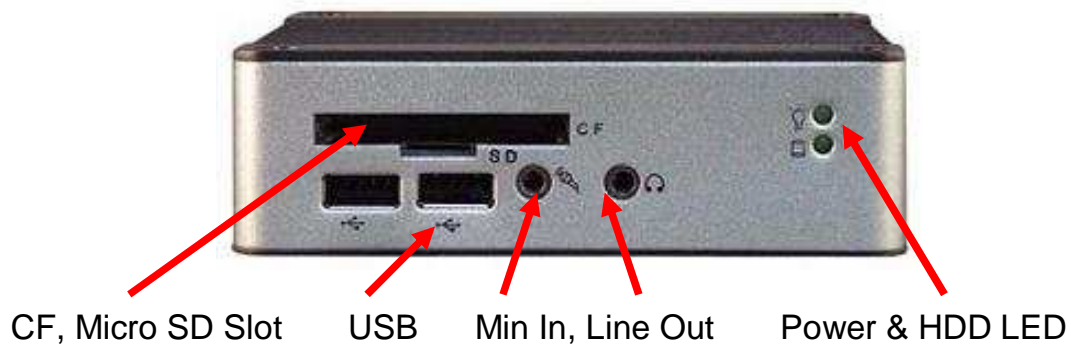

► Rear Connectors Outline

DC Power Jack PS/2 KB/Mouse VGA RJ-45 LAN USB

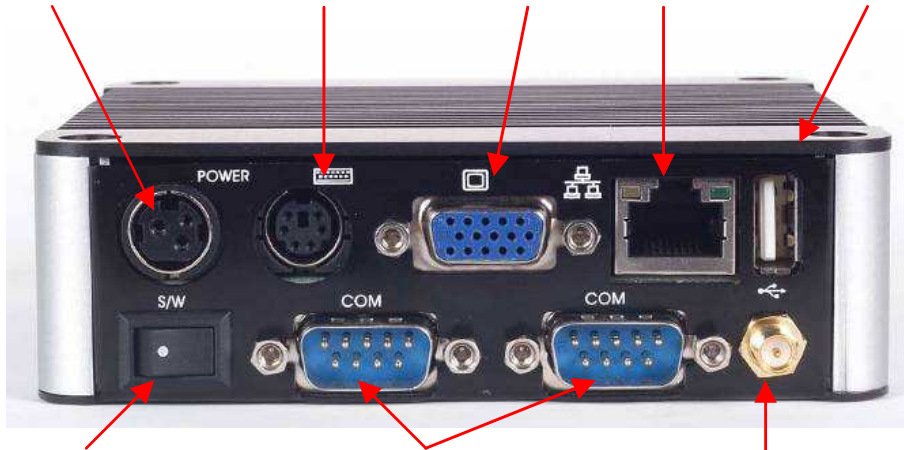

Power Switch

Serial Ports

Wireless ANT (Optional)

DC Power Jack 2nd LAN VGA RJ-45 LAN USB

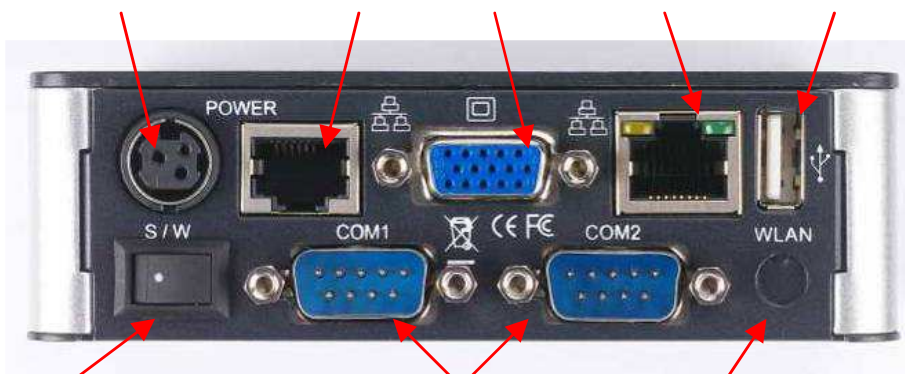

Power Switch

Serial Ports (Optional)

Wireless ANT (Optional)

Pin Assignments

J8: PS/2 Keyboard or Mouse – 6-pin Mini-Din Connector

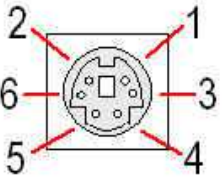
	Pin #	Signal Name
	1	KBCLK
	2	PMCLK
	3	GND
	4	KBDAT
	5	PMDAT
6	SB5V	

J13: Power SW – Push Button Switch

	Pin #	Status
	I	ON
	O	OFF

J12: DC-IN (5V) – 3-pin Mini-Din Lock Pin Socket

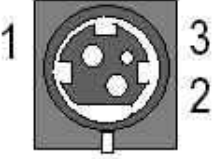
	Pin #	Signal Name
	1	VCC
	2	GND
3	NC	

J3: USB (90°) – 4-pin USB Type 1 Connector (Vertical Type)

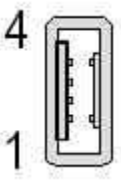
	Pin #	Signal Name
	1	VCC
	2	USB0-
	3	USB0+
	4	GND
	5	GGND
6	GGND	

LEDS: POWER ON / OFF & HDD RW

	LED Color	State
	Green	Power On
	Green	HDD On
	Green Flashes	HDD RW

J15: VGA – 15-pin D-Sub Connector

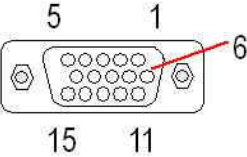
	Pin #	Signal Name	Pin #	Signal Name	Pin #	Signal Name
	1	MR	6	GND	11	NC
	2	MG	7	GND	12	VCC
	3	MB	8	GND	13	HYSYNC
	4	NC	9	NC	14	VSYNC
	5	GND	10	GND	15	VCC

J4, J5: USB (USB2): For connection to external USB device –4-pin USB Type 1 Connector (H)

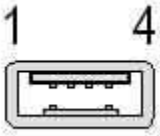
	Pin #	Signal Name
	1	VCC
	2	USB2-
	3	USB2+
	4	GND
	5	NC
6	NC	

J9, J11: COM - 9-pin D-Sub Connector

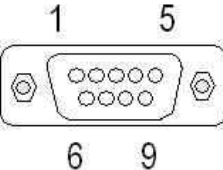
	Pin #	Signal Name	Pin #	Signal Name
	1	DCD1	2	RXD1
	3	TXD1	4	DTR1
	5	GND	6	DSR1
	7	RTS1	8	CTS1
	9	RI1	--	--

LAN: RJ-45 Connector

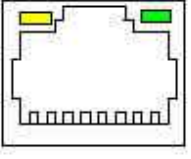
	Pin #	Signal Name	Pin #	Signal Name
	1	FTXD+	2	FTXD-
	3	FRXIN+	4	NC
	5	NC	6	FRXIN-
	7	NC	8	NC

Chapter 6

Taking Care of your EBOX

This section gives you some guidelines on using EBOX-3300A/ 3310A series – Safe using, Storing and Handling.

Storing

- ▶ Do not place EBOX-3300A/ 3310A series in a location that is subject to:
 - Heating sources, such as stove, oven, heater, radiator or air duct
 - Direct contact from sunlight
 - Rain or moisture area
 - Excessive dust accumulation area
 - High humidity place
 - Constant or occasional mechanical movement, vibration or shock
 - Strong magnets or magnetic fields or magnetically unshielded speakers
 - Ambient temperature of more than 95°F (35°C) or less than 32°F (0°C)

- ▶ Do not place other electronic device or electrical equipment near EBOX-3300A/ 3310A series. The electromagnetic field of the EBOX-3300A/ 3310A series may cause interference subjecting to malfunction.

- ▶ Provide adequate air ventilation (circulation) to prevent internal buildup of heat. Do not place EBOX-3300A/ 3310A series near the wall, behind the curtains or draperies, in between two books that block its ventilation slots. Leave a space of at least 8 inches (20cm) behind the sides and back panel of the EBOX-3300A/ 3310A series.

- ▶ Change of environmental temperature: Problems may occur when there is a sudden change of environmental temperature, or if the EBOX-3300A/ 3310A series is brought directly from a cold location to a warm one, moisture may condense inside EBOX-3300A/ 3310A series. Turn off the device, and contact your nearest dealer.

- ▶ Check the surrounding appliance(s) before using EBOX-3300A/ 3310A series. Since the EBOX-3300A/ 3310A series uses high-frequency radio signal and may interface with radio or TV reception causing interference or poor signal display. When this happens, relocate the EBOX-3300A/ 3310A series by a suitable distance away from the set.

- ▶ Do not drop the EBOX-3300A/ 3310A series from the working table nor place heavy objects on top of it.

Using Cables for Connection

- ▶ To avoid problem, use only the specified interface cables in your accessory bag. The supplier will not be responsible for the connection arising from the other unspecified peripheral equipment.
- ▶ Do not use cut or damaged cables for connection.

Cleaning Your VESA PC

- ▶ Clean the VESA PC with a soft, dry cloth or a soft cloth lightly moistened with a mild detergent solution.
- ▶ Do not use any type of abrasive pad, scouring powder, or solvent such as alcohol or benzene, as these may damage the finish of EBOX-3300A/ 3310A series.
- ▶ When a solid object falls or a liquid spills onto the EBOX-3300A/ 3310A series, turn off the EBOX-3300A/ 3310A series immediately and unplug the LAN and power cables. Contact a qualified person or your dealer to check the EBOX-3300A/ 3310A series before you use it again.
- ▶ Always disconnect the power cord from the power source before cleaning the EBOX-3300A/ 3310A series.

Troubleshooting

This section describes the techniques of resolving some basic problems that you encounter when using EBOX-3300A/ 3310A series. For more troubleshooting guidelines, please contact your nearest dealer for technical support.

Troubleshooting Your VESA PC

A. VESA PC

- ▶ Make sure the EBOX-3300A/ 3310A series is properly secured and plugged into a power source before it is turned on. Make sure the power indicator shows the power is on. See section 2 for more information about “EBOX-3300A/ 3310A series Overview”.
- ▶ When the EBOX-3300A/ 3310A series is plugged into a power strip or the UPS (Uninterruptible Power Supply), make sure the power strip or UPS is turned on and working normally.
- ▶ Check if your VGA or LCD monitor is properly plugged into a power source and turned on. Make sure the brightness and contrast controls are adjusted correctly. See the manual that came with your display (monitor) for details.
- ▶ Check if your power control button does not function, by removing the AC adaptor. Wait for one minute, and then reattach all power connection before pressing the power button.
- ▶ Condensation may cause the EBOX-3300A/ 3310A series to malfunction for a while. If this happens, do not use the EBOX-3300A/ 3310A series for at least one hour.
- ▶ When you have checked all the above guidelines and the EBOX-3300A/ 3310A series does not work. Remove the power adaptor from the EBOX-3300A/ 3310A series, unplug the power cord, and plug it in again. Then turn on the power.
- ▶ When CF card compatible issue happened sometime, please try below setting and see if better. To set CF card as PIO mode in the BIOS settings as below:
 1. Power on and press into the BIOS settings.
 2. At PCIPnP selection, please set “PCI IDE BusMaster” to “Disabled”.
 3. Press <F10> to save and exit the BIOS settings.And test it again.

B. BIOS Error Message –

BIOS error message appears when my VESA PC starts

If the BIOS error message appears, press any key to resume or, hit to enter BIOS setup main menu, follow these steps:

1. Press , and the BIOS Setup main menu appears, check if HDD is detected. If it is not detected, use Direction keys <↑↓> to choose “AUTO” and then go back to the main menu by pressing <ESC>. Move your cursor down with Direction keys <↓>, and choose “Save Settings and Exit”; a message dialog appears as seen below, hit <Enter>.

“Save current settings and exit (Y/N)? Y”.

- Go to “Exit” menu using the Direction keys <↑↓> and choose the option “Load Optimal Defaults”, then press <Enter>. A message dialog appears as seen below, hit “Y” key and presses <Enter> to save and recover to the factory setting.

“Load Optimal Defaults (Y/N)? Y”.

```

Main    Advanced  PCIPnP  Boot    Security  Chipset  Exit
*****
* Exit Options
* Save Changes and Exit
* Discard Changes and Exit
* Discard Changes
* Load Optimal Defaults
* Load Failsafe Defaults
*****
                Load Optimal Defaults?
                [Ok]    [Cancel]
*****
                Select Screen
                Select Item
                Enter Go to Sub Screen
                F1    General Help
                F10  Save and Exit
                ESC   Exit
*****
v02.58 (C)Copyright 1985-2008, American Megatrends, Inc.

```

(BIOS Setup menu “Exit”)

C. “Operating System Not Found” –

A message indicating that “Operating system not found” appear when my VESA PC starts (Windows won’t start)

- ▶ Enter your BIOS setup main menu by pressing key, be sure that the C: drive is enable.
- ▶ If Windows still does not start, follow these steps to initialize the BIOS:
 1. Turn off the EBOX-3300A/ 3310A series.
 2. Remove any peripheral devices connected to the EBOX-3300A/ 3310A series.
 3. Restart the EBOX-3300A/ 3310A series.
 4. Press to enter BIOS Setup main menu window.
 5. Follow the steps as written in item **B. BIOS error message**.
- ▶ If you have just connected EBOX-3300A/ 3310A series to a CD/DVD or USB Drivers, remove these peripherals. And restart to confirm that the Windows operating system starts properly. If EBOX-3300A/ 3310A series continues to display the message “Operating system not found,” and Windows does not start, please contact your nearest dealer for servicing.

Chapter 7

Terms and Conditions

Warranty

The warranty terms for EBOX-3300A/ 3310A series are twelve (12) months from the beginning on the date of invoice. During the warranty period, DMP Electronics Will repair replace the product covered under this limited warranty.

Service and Support

DMP Electronics Inc. provides the technical support for hardware problems with your system throughout the warranty period. The technical support service is limited to configuration and operation of EBOX-3300A/ 3310A series sold by DMP Electronics Inc. The technical support service does not offer software tutoring or training.

Return Merchandise Authorization (RMA) policy

If the DMP staff or dealer determines that a part is defective. Purchaser must call our technical support service to obtain an RMA number before attempting to return any part. Please contact your nearest dealer to obtain an RMA number.

Purchaser must follow procedures as below :

1. Complete the DMP Electronics Inc. standard RMA Form and fax back to the RMA Department.
2. The RMA Number must be used within 7 DAYS.
3. The RMA Number must be shown clearly on your shipping label.
4. DMP Electronics Inc. must receive all Returns before a replacement will be sent.
5. The repair cost is depends on the parts, the damage reasons, and whether under warranty period. . .etc. The Seller will charge the Purchaser in a reasonable price.
6. A copy of the invoice for the RMA product(s) will also be shipped to Purchaser.
7. The freight of return to DMP Electronics Inc. is charged to Purchaser account and accompanied by an RMA number. Any Returns with freight collect will be refused and returned to you. After repairing, the cost of freight will be paid by seller.
8. DMP Electronics Inc. must receive all returned goods within the warranty period.

Shipping Policy

The Purchaser must pre-pay shipping for any defective system or parts returned under the warranty. DMP Electronics Inc. shall not be liable for risk of loss or damage during shipment of your returned system or parts if you fail to insure the shipment.

All products must be shipped back to DMP Electronics Inc. in original or equivalent packaging. DMP Electronics Inc. will ship the repaired or replacement product(s) to Purchaser by freight prepaid. Purchaser assumes the risk of loss. DMP Electronics Inc. shall not be responsible for failure of the delivery service to make on-time delivery.